



## INSIDE

- 1 **VHS Changes Virtual Rules of the Game**  
A teacher and superintendent from Center, Colorado, talk about their VHS experiences.
- 3 **Peach State Teachers Dig Their Teeth Into Sustainable Studies**  
Teachers in Georgia learn how to bring sustainable studies issues into their classroom.
- 5 **Student Scientists Take Haze Projects to Science Fairs**  
Students who participated in local science fairs prove winners with haze projects.
- 5 **Making Smarter Probes**  
A new, cheap microcontroller that makes probes smaller and lighter spawns SmartProbe™.
- 6 **Monday's Lesson**  
Try your hand at making an aircart from scratch and learn some physics principles along the way.
- 8 **Biological "Sandbox" on a Computer: Biologica**  
New genetics software addresses the complexity of living organisms.
- 11 **Perspective: New Visions for Education**  
A boom in inexpensive, powerful computers may never reach the classroom. Find out why.
- 12 **info@concord.org**  
Classroom teachers in Singapore; CC Services offers NetCourse training.



## Changes Virtual Rules of the Game

### Colorado Teacher and Superintendent examine Virtual High School strategies

One of the lowest wealth schools taking part in the [Virtual High School](#) is [Center High School](#), located in the San Luis Valley of Colorado. I asked the Superintendent of Schools how he could afford to free up valuable teacher time to take part in the VHS. His response was "It's a no-brainer. I give you one teacher and I get 30 new courses in our catalog." A year later, even though we knew technology issues had hindered student participation during the first term, we asked for a brief retrospective from him and from the teacher he selected to teach the first VHS course in his school. Their responses follow.

*Bruce Droste*

*Director, Virtual High School*

*Gary Kidd was the Superintendent of Schools in Center when the Virtual High School project started. He is now the Director of Information and Technology Services for the Littleton, Colorado, Public Schools:*

Building a technology infrastructure, integrating technology throughout our

curriculum, and participating in the Virtual High School were only one component of a larger restructuring project, called the Student Centered School, which the Center School District initiated at the opening of the 1992-93 school year.

The need to recreate the educational systems in Center was driven by our acceptance of the realization that the traditional paradigm of public education in America was not created with Center students in mind. The students in Center are just as bright, talented, and capable as students anywhere in the country. Yet the levels of poverty found in the San Luis Valley of Colorado present some unique challenges for educators and parents. We realized that the traditional solutions for at-risk students had not been successful. In order for graduates of Center schools to compete with graduates of more affluent urban and suburban schools, we had to change the rules of the game.

The first rule we changed was our attitude toward teaching and learning in the late 20th century. It is obvious to all of us

*(continued on page 2)*

#### LINKS ON THIS PAGE

[Virtual High School](http://vhs.concord.org)—vhs.concord.org

[Center High School](http://www.center.k12.co.us/cntrhig.htm)—www.center.k12.co.us/cntrhig.htm

## The Concord Consortium

### Editor

Robert F. Tinker

### Managing Editor

Lee McDavid

@CONCORD is published three times a year by the Concord Consortium, a not-for-profit educational research and development organization dedicated to educational innovation through creative technologies.

Copyright ©1998 by the Concord Consortium. All rights reserved. This publication may be reproduced for noncommercial uses without written permission, provided appropriate acknowledgment of the Concord Consortium accompanies the reproduction.

The Concord Consortium  
37 Thoreau Street, Concord, MA 01742  
(978) 369-4367, FAX (978) 371-0696  
info@concord.org  
<http://www.concord.org>

The projects described in @CONCORD are supported by grants from the National Science Foundation REC-9553639, REC-9896075, REC-9725524, REC-9554198, ESI-9896068, ESI-9554162 and CDA-9720384, and the U.S. Department of Education R303A60571 AND R303A70182.

We also receive donations from corporations and individuals. All opinions, findings, conclusions, and recommendations expressed herein are those of the authors and do not necessarily reflect the views of the funding agencies.



### Rules of the Game

*continued from page 1*

involved in the [Virtual High School](#) program that students today are different than they were ten years ago. Yet many teachers are still teaching the same material in the same way. Everything in the old paradigm was designed to be taught without technology. Hence, the first 15 months of our restructuring around technology was spent questioning everything. We kept some things, eliminated others, and revised the remaining. At that point in the process, most of our hardware was three generations behind the curve, but so were our attitudes. I presume the same is true in most schools today, despite what most of us like to believe. As a consequence, before we installed a single new computer, we started 15 months of extensive staff development. Put simply, our attitudes determine the ways we think; how we think determines our actions.

Our district vision statement speaks to our commitment to our people, our commitment to partnership, and our commitment to excellence. Through the work of our staff and their willingness to provide the opportunities all of our students deserve, and the commitment of a community to accept the challenge of change on behalf our students, we have created a learning environment very different from the school district of four years ago. We have created an environment which personifies our vision.

Children have always been explorers, born with the ability to interact and learn about the world around them. Children between the ages of three and 18 are being

referred to as the "Nintendo generation" or the "Net generation." They live in a world which is increasingly interactive, communications intensive, and knowledge based. They are the standard bearers in the information revolution, having never known anything else. Because of their ease in and with the information age, society needs their active involvement and interaction.

The concept of education is being redefined by a world we can barely imagine. Everything we have known as reality is going to be challenged or changed, yet our challenges are undefined. What is going to happen by the time our current generation of students leaves our high schools? We have the responsibility to let go of the past in order to embrace the future. And the future has arrived; it just hasn't been evenly distributed.

*Terri Day has taught science at Center High School for 10 years and is teaching Introduction to Microbiology for VHS:*

My experiences with Virtual High School have reminded me of my first year or two of teaching. I have had those same feelings

**I have really enjoyed planning a course that I would never get to teach in my district because of small enrollment and small staff.**

of trying to stay caught up with the students and working hard to get everything organized. Learning new software made those feelings of not knowing how everything in the school works come up again, also.

I have really enjoyed planning a course that I would never get to teach in my district because of small enrollment and small staff. We are able to offer the basic courses with a few advanced ones, but none as specialized as this course. Although the planning and implementation of this

#### LINKS ON THIS PAGE

[Virtual High School](http://vhs.concord.org)—vhs.concord.org

[Center High School](http://www.center.k12.co.us/cntrhig.htm)—www.center.k12.co.us/cntrhig.htm

course took many, many hours of my time, I enjoy this aspect of the [Virtual High School](#). It allows me to get excited about my field again.

Some aspects of teaching a VHS course are the same as a “real” course. I found that the students fall into predictable personality types. I have students that are really self-motivated and can follow directions without any extra help, some need a little extra push but then move along well, and those that just “don’t get it” no matter how much instruction they receive or how much push I provide. They are no different than my “real” students. I remember wondering whether I could get to know my virtual students very well through this type of learning, but I feel that I do know them.

As with any course, I am constantly refining and modifying the lessons as needed. A course is never done, never exactly the way you envision. This is particularly true with courses that rely heavily on information from the Internet, which my course does. These students visit web sites for the information they need to complete the course. Sometimes these sites change from one week to another, so I spend a lot of time going back to my original sites looking for changes and then refining the lessons accordingly. I also spend time looking for new sites that would be helpful for my students.

VHS has allowed me to grow as a teacher. Although it takes time, I have enjoyed learning lots of new techniques that apply to all classes, not just virtual ones. I hope that this experience has made me a better teacher, I know I have become a better learner. @

# Peach State Teachers Dig Their Teeth into Sustainable Studies

by Jack Byrne

Sustainability is a complicated topic. In March, 50 teachers from the Cobb and Fulton County (Georgia) School districts took up the challenge to begin developing classroom materials that would explain sustainability to their students. Whether teaching kindergarten or high school, these teach-



*Dr. George Stickel from Harrison High School in Cobb County, Georgia, presents a small group report to the ESF participants.*

ers began the task of incorporating sustainability issues into their varied curriculums.

But first, they had to agree on why it was important to do so, especially when it meant learning new technology tools to support their teaching curriculum.

“It is important . . . because [teachers] are the bridge between such a future and the kids who will shape it,” one group of teachers replied.

They all agreed that kids are the key to the future. “One teacher said it was like a treasure chest and we have the key,” said Donna Culver, the facilitator at the workshop, which was an orientation for

[Education for a Sustainable Future \(ESF\)](#), a project of Concord Consortium’s [Center for a Sustainable Future \(CSF\)](#) and the Cobb County Public Schools ([@CONCORD, Winter 1998](#)).

More than 250 K-12 teachers applied to participate in this first round of curriculum development, and this was the first time the selected teachers had met.

Dr. Richard Benjamin, Superintendent of Cobb County Schools and co-Principal Investigator of the project, noted that as a superintendent it is easier for him to find out who attended school each day than what it was that each child was learning. “We have a situation where attendance is mandatory and learning is optional,” he said.

A key component of the ESF project is the use of technology tools, such as computers and the Internet, to help students understand local and worldwide sustainability issues. Benjamin expressed his hope that the ESF project will lead the way in this respect. Two ESF web sites (see URLs below) have already made available a number of items, such as a resource database, a bookstore, a calendar of events, a sample curriculum template, and other features.

Teachers were able to experience the immediacy of an online chat session when they logged on to talk with Keith Wheeler, the ESF co-Principal Investigator, from Vermont. A “contagious enthusiasm” among the teachers in the chat session

*(continued on page 4)*

---

#### LINKS ON THIS PAGE

VHS—[vhs.concord.org](http://vhs.concord.org)

ESF—[csf.concord.org/esf](http://csf.concord.org/esf)

CSF—[csf.concord.org](http://csf.concord.org)

@CONCORD Winter 1998—[www.concord.org/pub.html](http://www.concord.org/pub.html)

Harrison High School—[www.cobb.k12.ga.us/~grants/particip.htm](http://www.cobb.k12.ga.us/~grants/particip.htm)

## Peach State Teachers

*continued from page 3*

made it evident how communication can be enhanced by technology.

There still remained the development of a definition of sustainability. “We started with a picture of a tree,” explains Donna Culver, “with three main roots—quality of life, a prosperous economy, and a healthy environment—and we described what those things mean in their local community.” Thinking locally is crucial to gaining a clearer understanding of sustainability. It’s easier to talk first about how water quality, air quality, urban sprawl, and transportation affect your community before thinking about global issues.

In order to understand their communities better, participants discussed a short version of a Community Cultural Profile, a series of questions about different characteristics of a community. Here are some examples:

- ▼ Where do people in your community see each other on a regular basis (e.g., town meetings, parks, grocery stores, shopping malls)?
- ▼ In general, what kinds of opportunities exist to get involved in community activities?
- ▼ What percentage of people who live in your community work in the community? Outside the community? Do you have any thoughts on why these trends are occurring?
- ▼ Is telecommuting on the rise?

Many of the groups found themselves discussing the meaning of the word “community.” The workshop itself represented a community they had formed that day. Each person was part of a geographic community. And many were also members of virtual communities. One person was

inspired to organize a group from his geographic community in order to discuss the questions back home.

“I explain sustainability this way,” says Culver, “if our communities are a trust fund, we can only touch the interest, not the principle.”

Now imagine what your community would be like if you used only the interest, or if you dug into the principle. If the result was represented by the branches of the tree, what would your community look like twenty years from now? One group of teachers chose to represent both scenarios and came up with a tree that was alive and vigorous on one side and sickly and drooping on the other. They agreed that the healthy side was a result of positive sustainable actions, represented by the three agreed upon tenets: quality of life, a prosperous community, and a healthy environment.

After beginning with a shaky understanding of sustainability, it was apparent that these teachers were quickly developing a realistic sense of the current challenges facing their community and optimism about their ability to create a more sustainable future.

But how to bring this understanding to the classroom? Teachers explored the connections between the subjects and grades they taught, taking advantage of the wide experience that the assembled teachers had in K-12 classrooms.

“Stewardship” became an important topic when connecting teaching and sustainability. Participants brainstormed connections between their teaching roles and the following:

- ▼ An understanding of 1) resource allocation, use, and renewal, and 2) the responsibility society has to make these resources available to future generations.
- ▼ Individuals, institutions, and corpora-

tions taking full responsibility for the social, environmental, and economic consequences of their actions.

The day ended with a presentation by Jim Hartzfeld of Interface Research, a subsidiary of Interface Corporation, a \$1.2 billion a year tile, carpeting and flooring company. Interface is an example of a company which has changed its corporate vision to embrace sustainability throughout their worldwide operations. Their introduction to a recently published corporate sustainability report states:

*There are no federal agencies regulating sustainability, no charts or graphs to tell you or us whether or not we are succeeding. We had to create this ourselves. And it wasn't easy. . . . More than anything else, this report describes our road map to sustainability – as we see it. If it helps you, use it. If you can show us a better way, please do. We are all in this together.*

The next step for ESF is a week-long summer institute (June 22-26) which will result in materials for the opening of classes in the Fall.

In one day fifty teachers demonstrated how community can be defined as a group of people meeting for the first time to accomplish a goal, and succeeding. @

*Jack Byrne is Project Director for the Center for a Sustainable Future and co-Project Director of Education for a Sustainable Future. [esfinfo@concord.org](mailto:esfinfo@concord.org)*

---

LINKS ON THIS PAGE

[Education for a Sustainable Future](http://www.concord.org/esf)—[csf.concord.org/esf](http://www.concord.org/esf)

# Student Scientists Take Haze Projects to Science Fairs

by Dr. David Brooks  
and Carolyn Staudt

Projects Build Confidence – and Win!

Measuring atmospheric properties such as haze is science on the border between what our own senses observe and what must be measured with instruments. We can see when air is polluted and hazy, but we need instruments to provide a quantitative understanding.

Haze-SPAN, an informal collaboration of students as well as amateur and professional scientists, provides information to students on how to measure haze and how to submit the data they collect to a web site ([@CONCORD, Spring 1997](#)). Any interested student can log on and become a student scientist.

Vanessa Carr, a high school freshman in Lexington, Massachusetts, won first prize at her school science fair, placed 8th at the regional level, and has advanced to state competition at MIT for work she did with haze. “I learned how to work through the problems that the project entailed and how to best use and interpret the data,” she explained. “It built my confidence as a scientist because I was able to make conclusions in an independent experiment.”

Meantime, in the Mojave Desert, Casey Gorish, a 7th grader, noticed that northerly winds blew in white dust that clouded the sky. “I thought that the VHS-1 (sun photometer) would help me measure the haze and maybe tie it to Owens Lake by observing the winds,” he explained. Casey placed at his county science fair with a haze project, and plans to post his data to the haze web site.

In Roanoke, Virginia, Brent Jones

plans to submit an expanded version of his 8th grade haze project to a science fair next year. “I am still fascinated by the project,” he said. “I intend to take readings throughout the summer to include hazy periods when we experience thermal inversions.”

Competitors beware. @

*Carolyn Staudt is curriculum developer at the Concord Consortium. Dr. David Brooks, an atmospheric physicist from Drexel University, has been a Haze-SPAN online expert and is Principal Investigator for a GLOBE project on haze. If you want to get involved with haze research, visit the Haze-SPAN web site listed below.*

## Making Smarter Probes

by Stephen Bannasch

In the Science Learning in Context (SLiC) project we look at how science learning and investigation can be improved when kids use mobile computers and probes. When we put 20 kids using eMates™ with probes alongside a stream and had them measure temperature, light, pH, and dissolved oxygen, some interesting strains were put on equipment which worked fine when sitting on a lab bench back in school.

We discovered there were too many boxes and cables. The probes were connected to a signal processing box which was connected to an interface box which was connected to the serial port on the computer. Holding all this and a computer while measuring in a stream is sometimes more than a two-student job. The six AA batteries in the interface box ran down too fast and came loose occasionally.

Early in the SLiC project we developed the Concord Consortium Serial Box Interface (CCSBI) and based it on a new inexpensive 8-pin microcontroller. Because

the CCSBI is smaller and lighter than the older serial interface, uses a single 9V battery, and consumes very little power, it made mobile investigation more practical. Later we realized we could do better by getting rid of the interface box entirely and making a smarter probe.

A SmartProbe™ combines a sensor, analog-to-digital conversion, a microcontroller, memory for saving its calibration, serial communication, and power-management circuitry all in one small, convenient package. The design goal is, given economic constraints, to increase the ease of use and reduce the opportunities for mistakes and failure. SmartProbe features include:

- Remembers its calibration. Using the calibration it reports back to the computer in physical units instead of raw data.
- Uses little power and, when possible, eliminates the battery entirely by get-

*(continued on page 10)*

---

#### LINKS ON THIS PAGE

Haze-SPAN—[www.concord.org/haze](http://www.concord.org/haze)

SLiC—[www.concord.org/proj-slic.html](http://www.concord.org/proj-slic.html)

GLOBE—[www.globe.gov](http://www.globe.gov)

SmartProbe—[concord.org/slic/smartprobe.html](http://concord.org/slic/smartprobe.html)

@CONCORD Spring 1997—[www.concord.org/pub.html](http://www.concord.org/pub.html)

An aircart design was developed by the [Hands On Physics](#) project as a primary object for students to build as they learn about motion. HOP is a curriculum in which students construct their understanding of physics as they build their own equipment, using inexpensive electronic components and readily accessible materials. It stresses teamwork as well as individual responsibility for learning.

### Introduction

Dragging heavy objects over rough ground or choppy water is an age-old drudgery. Humans have invented many ways to make this simple process easier. We invented the wheel, refined it, and used it in many clever ways. Even more amazing is the fact that we created

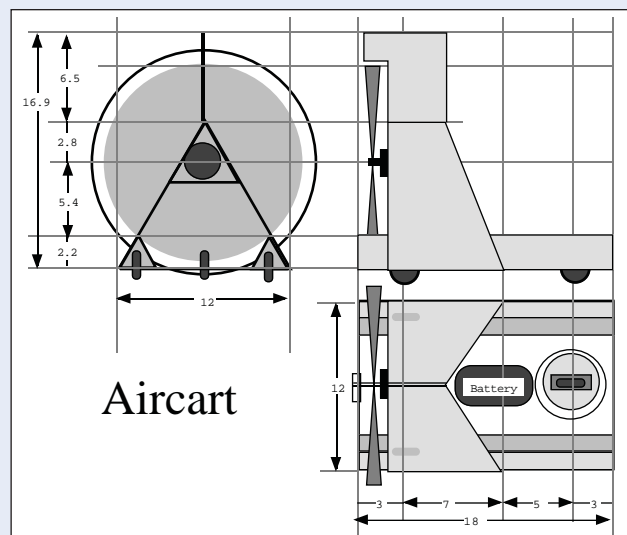

Figure 1. Aircart diagrams.

vehicles which fly! Vehicles which travel on land may be moved forward by pushing backward on the surface of the roadway and boats may be propelled by pushing backward on the water they float in. To fly, what can you push against? The spinning “air screw” or propeller was developed to push against the obvious - air. Not only did this technical innovation allow engine-powered flight, but it provided another possibility for moving terrestrial vehicles as well. Test this possibility with a model.

### Performance Criteria

This aircart must use a propeller powered by no more than 3 volts.

You may want to maximize its top speed, its ability to speed up, or its load carrying capability. There are other possibilities.

### Tools

- Two dangerous tools are required for this project: a



very sharp knife and a superhot soldering iron. Either of these tools can cause painful injury, so be alert and use them with care. A small knife with a segmented blade works well for cutting cardboard, and a soldering iron and solder for making good electrical connections.

- A hot glue gun allows quick assembly. Because the hot glue cools quickly, you must be confident about the placement of glued parts and you must work rather rapidly.
- A ruler is necessary for measuring and for use as a straight edge.
- Although a compass is designed for drawing circles, it has a sharp point which also makes a good hole punch. Of course you can also use it to draw circles.
- Use a work-board for cutting and gluing. If a work-board is not available, use pieces of scrap cardboard. Do NOT cut directly on your desk or workbench.

### Materials

Cardboard: corrugated cardboard is a good material for building small structures.

### Parts & Pieces:

- [Radio Shack](#)™ 800-THESHACK
- 275-409 slide switch (2/pk)
- 270-324 battery clips (9v)
- 270-382a AA battery holder
- 273-223 DC Motor

# Monday's Lesson

## Technology-Enhanced Exercises

### “Hands On Physics”

by Hilton Abbott and Bruce Seigler

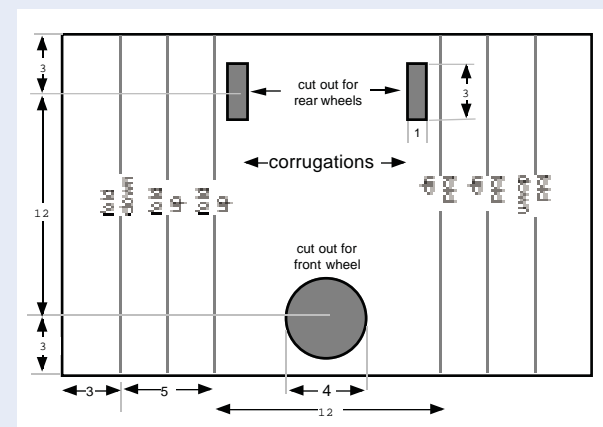

Figure 2. Aircart base.

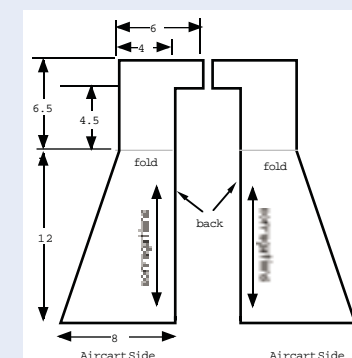

Figure 3. Aircart sides

# ondays Lesson

## Technology-Enhanced Exercises

### “Hands On Physics”

by Hilton Abbott and Bruce Seiger

#### Local Hobby Shop

Cox #5d4p propeller, 5" black plastic  
Mangelsen's #25173 wood wheels 3/4" x 3/16"  
AA batteries  
pop rivets, aluminum 1/8" diam, 1/4" grip

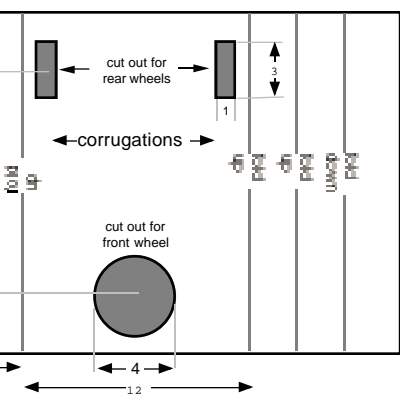

#### Construction

The design presented here has been tested and works well. (Fig. 1) The strength and rigidity of this aircart depends on several triangular structures. During construction it is important to maintain equal sides and 60 degree angles so things will fit together nicely.

1. Base (Fig. 2): The base may be cut from an 18cm x 28cm piece of corrugated cardboard. The aircart is built up from this base; wheels attach to it and the motor is mounted on it. Cut out the base, and score the folds. Fold the sides to make triangular beams. The flaps should meet in the center and cover the front wheel hole. Mark this hole on the flaps and cut out the semicircles. Glue carefully, the angles must be 60 degrees or the aircart sides won't fit right.

2. Sides (Fig. 3): The aircart sides form a structure for attaching the motor. When glued to the base, they form two legs of an equilateral triangle.

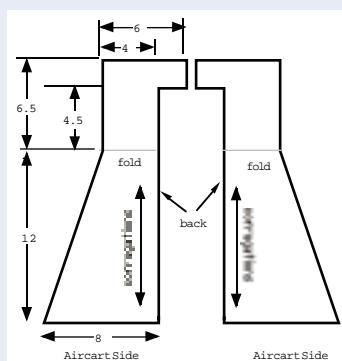

Figure 3. Aircart sides

3. Propulsion System: Cut the motor mount from a piece of cardboard 4cm x 12cm. The corrugations should run lengthwise, perpendicular to the folds. Extra glue is recommended because the motor tends to break loose from its mount in collisions. Glue the propeller onto the motor shaft and attach the motor mount to the aircart sides.

4. Assembling the Frame (Fig. 4): Glue the sides, with the motor in place, onto the triangular beams of the base.

5. Wheels: Pop rivets may be used for bearings in the wooden wheels. Pull the rivet to the



Figure 4. Aircart frame.

center of its shaft, and push the rivet into the hole in the wheel. Both ends of the pop rivet shaft can be glued directly onto the bottom of the aircart.

6. Steering Assembly: A steerable front wheel is highly recommended. The steering arm can be built up in four layers. The arm itself, with the front wheel attached, is on the bottom. Two pivot disks are glued on top of the arm. This pivot disk fits up into a circular hole cut in the base of the aircart, and then a cap disk is glued on top to keep the whole thing in place.

7. Propeller Guard (Fig. 5): A propeller guard will help protect your fingers and improve the structural strength of the aircart. The guard is a piece of clothes-hanger wire bent in a circle with a radius of 7.5cm.

8. Wiring (Fig. 6): After the motor assembly has been safely glued in place, you can add a battery and a switch and then wire it up. Soldered electrical connections are recommended.

#### 9. Testing

Average Speed: Calculating the average speed is easy. How “fast” is your aircart? How fast will it go in one meter? How fast in three seconds?

Changing Speed (Fig. 7 & 8): To study the changing speed of the aircart, several sequential time measure-



Figure 5. Steering assembly

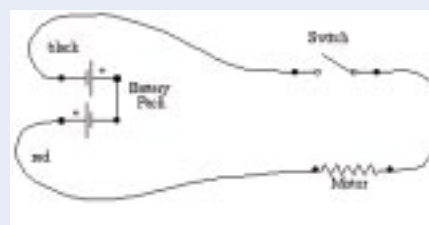

Figure 6. Circuit.

ments must be made. You can use a lap-timer stopwatch (Radio Shack #63-5013, 9 lap timer \$25) to time the aircart as it moves along the floor, or if a [Microcomputer-Based Laboratory](#) apparatus or the CCSR (see “Making Smarter Probes,” page 5) is available, you can use it to study the aircart moving a shorter distance on top of a lab bench.

To measure changing speed with a stopwatch, set up

(continued on page 10)

#### LINKS ON THIS PAGE

[Hands On Physics](http://www.concord.org/HOP)—www.concord.org/HOP

[Microcomputer-Based Lab](http://www.concord.org/pubs/mblimpact.html)—www.concord.org/pubs/mblimpact.html

Concord Consortium: [www.concord.org](http://www.concord.org)

# A Biology “Sandbox” On a Computer: BioLogica

by Paul Horwitz

**B**iology is not like physics. Physicists are taught to analyze everything down to irreducible components (molecules to atoms to protons to quarks to . . .). Early on, biologists learn to cope with the irreducible complexity of living things. For several years now, we have been creating and experimenting with software that embodies a physicist’s conception of biology.

**GenScope™** is a computer-based manipulative (CBM)—a manipulable model that we have created to help students learn genetics. We described the program last month ([@CONCORD, Winter 1998](#)), and you can learn more about it by visiting our web site. Suffice it to say that GenScope cuts a long but narrow swath through the biology curriculum, touching on DNA, chromosomes, cells, organisms, pedigrees, and populations, but viewing each through the restricted focus of genetics. For example, cells in GenScope are entirely undifferentiated and contain nothing more than chromosomes. Their only behaviors are mitosis and meiosis, and their only function is to carry genetic information from one generation to the next.

But biology does not suffer gladly such compartmentalization. Seemingly straightforward questions—e.g., “Is cancer a genetic disease?”—cannot be answered by reference to genetics alone, but may entail a discussion of the life cycle of retroviruses, the effect of environmental factors on DNA, the role of DNA in protein formation, the function of proteins in regulating cell division and death, and metastasis and

histologic influences on cells. Biology is integrative, not reductionist.

What is to be done? We are pleased to announce the imminent appearance of a new CBM, to be named **BioLogica™**, that will address the mismatch between the narrow focus of GenScope and the wide-ranging nature of biological reasoning. BioLogica will expand significantly on its illustrious predecessor, both in content and, we trust, in pedagogical power.

## Molecules and Cells

BioLogica is smart. It knows about molecules beyond DNA; it knows that cells contain many wondrous things besides chromosomes; it knows about relations between cells. Actually, it doesn’t really “know” any of these things, of course, but it has models of them and, like GenScope’s, the models are manipulable by the student, the results of manipulations of any one model being instantly reported to all the others. Thus, BioLogica imitates life in being essentially a collection of semi-autonomous entities (molecules, cells, tissues, organisms) that interact through the exchange of information. This makes BioLogica quite complex.

Leaving aside a certain undeniable technological hubris, why do we need such a complicated program? Our ultimate goal is to help students think like biologists. Any computer program forces its users to think in ways that reflect the way the software is constructed. (To the person whose only tool is a spreadsheet, every problem looks like a grid.) By encompassing the complex interactions that characterize living things, BioLogica

will give students a biological “sandbox” within which to hone their reasoning about living things. Here is an example.

Let’s go back to that seemingly simple question about cancer. Imagine that BioLogica exists, and we have challenged a student, or more likely a pair of students, with a puzzle. We have given them an organism—perhaps a fictitious one like the GenScope dragons, perhaps a simplified model of a real one—that harbors a colony of cancerous cells. The problem for the students is to locate these cells, figure out what has gone wrong with them, and if possible fix it.

Cancerous cells generally look different from normal ones under a microscope. BioLogica will model this difference, probably by linking to photographs of real cells, so by comparing these the students should be able to find the “bad actors.” BioLogica will also show cells as they appear in textbooks, with some enhancements. Animated diagrams will depict the flow of critical factors from one organelle to another or across the cell membrane. A different view will highlight features of the cytoskeleton, the complex network of protein filaments that extends throughout the cytoplasm. Yet another will display the life cycle of the cell. This latter feature will demonstrate to the students that the cancerous cells are continuing to divide long after the normal ones have become quiescent. The question is, why?

For pedagogical purposes we may have to simplify matters somewhat, but BioLogica will faithfully model the basic concept of a cell cycle control system mediated by molecular reactions. We will offer students an array of tools with which

---

LINKS ON THIS PAGE

[GenScope](#)—genscope.concord.org

[@CONCORD Winter 1998](#)—www.concord.org/pub.html



to measure the flows and concentrations of different proteins. Some of these proteins enable the cell to divide. In normally functioning cells these proteins become inactivated under certain conditions—e.g., in response to overcrowding from neighboring cells—and the cell essentially “hibernates.” However, when the gene that codes for it is mutated the result can be a failure of the protein to inactivate, resulting in uncontrolled proliferation (mitosis) of the affected cell and the growth of a tumor.

In order to “cure” their organism’s cancer, students must first compare its cancerous cells to normal ones. They will find that in the normal cell certain reactions fail to occur because of the absence of a “growth factor” molecule. In cancerous cells, however, the protein that initiates the reaction has been altered and remains active even in the absence of the growth factor. Once they have identified the defective protein, the students can “drop down” to BioLogica’s molecular level, to examine it and see why it behaves so anomalously. By tracing the flow of the molecule backwards they can observe it being created from DNA, and they can use this information to determine which gene produces it. Finally, by comparing this gene to the normal one, they can locate the mutation and perhaps even identify, from a “rogues gallery” of suspects, the retrovirus that caused it.

### Scripting BioLogica

A piece of software as complex as BioLogica can be difficult to use in the classroom. For one thing, each investigation, such as the one we have described, requires a particular configuration of the program—cells must be set up with appropriate pathologies, available instruments must be carefully chosen so as to guide the investigation without constrain-

ing it unduly. It will be useful if the software itself can pose the problem to the students, and even more useful if it can monitor their progress, offer suggestions, and periodically ask them questions. Most important of all would be to give curriculum designers the ability to construct a suitable context for student investigations by linking them to real world scientific questions or social or ethical issues.

We plan to do all this by integrating BioLogica with a powerful scripting tool. We are developing a general purpose Educational Application Scripting Language (EASL) which will enable us to embed stories and puzzles in BioLogica,

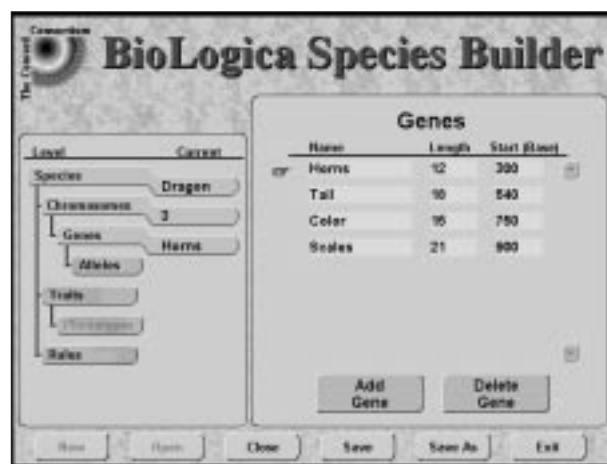

*BioLogica allows kids to create their own species by assigning traits and characteristics to an organism.*

using text and multimedia. EASL will also enable us to monitor and react to student actions, and to communicate directly with BioLogica.

Scripts will enable us to do many things. We will experiment, for instance, with the possibility of providing a real world context for student investigations by having a scientist (or an actor playing one) describe the research problem she is working on and offer encouragement and advice as students proceed to try to solve it. We will exploit the scripts’ ability to monitor student actions by attempting to identify “teachable moments” and providing feedback. In the scenario described

above, for instance, we could have the script react when the student team isolates a particular protein or identifies its gene.

An important goal of our project is to simplify the writing of scripts, so that teachers, educational researchers, and curriculum developers, with no expertise in programming, will be able to write their own scripts or modify those of others. We will explore the use of “wizards” that will guide script developers possibly through a dialog in an interview format. Our goal will be to make script writing no harder than absolutely necessary. Though it may be a challenge to produce pedagogically useful scripts, at least we will make it easy to produce scripts that “work” (in the sense of not crashing the computer!) and do what the author intended.

BioLogica is being produced by Bob Miner and Ed Burke, using Java on the Windows platform. Eventually, we plan to port the software to the Macintosh platform. Bob is responsible for the underlying engine and associated user interface, and Ed is implementing the EASL environment. They expect to have a demo version, which will largely recapitulate the functionality of [GenScope](#), by July 1998, and a working program by the end of the year. Other members of the BioLogica team include Paul Keefe, who writes scripts for GenScope using AppleScript (a time-consuming and frustrating process that confirms the importance of EASL). Joyce Schwartz and Joanna Lu are designing scripts and producing paper-and-pencil prototypes. Mary Ann Christie is studying students using GenScope and will shortly do the same for BioLogica. I watch over the group and write articles like this one. @

*Paul Horwitz is Principal Investigator of the BioLogica Project, which will be available in Spring 1999. [gsinfo@concord.org](mailto:gsinfo@concord.org)*

LINKS ON THIS PAGE

[GenScope—genscope.concord.org](http://genscope.concord.org)

## Smarter Probes

*continued from page 5*

- ting all necessary power from the computer's serial interface.
- No on-off switch, thereby eliminating a potential source of confusion in the field. Whenever an active serial interface connection is detected it automatically turns itself on.
- A standard three-wire RS-232 serial communication protocol so that it can be connected to the widest range of computing hardware.
- A communications protocol to enable code, commands and data to be passed between the computer and the probe.
- A power source with the capability to record data while disconnected from the computer.

With these features in mind, the first SmartProbe we developed was the Concord Consortium Sonic Ranger™ (CCSR). The CCSR uses a microcontroller and a Polaroid ultrasonic transducer to collect distance data and communicate that data serially to a computer.

We adapted the older Mac Motion software to work with the CCSR. Additionally, we developed software for an extremely portable computer, the PalmPilot™. The software on the Pilot displays real-time distance, velocity, and acceleration graphs. The CCSR uses a special power saving circuit design so that it can operate continuously for 25 hours on four AA alkaline batteries. This combination makes an extremely portable and powerful tool for exploring the kinematics of motion inside and outside a school.

We're also working on a SmartProbe for temperature that connects to a serial port. We estimate a parts cost of under \$10 in 1000 unit quantities. A key element in the low cost is the TMP03 temperature sensor from [Analog Devices](#). This sensor outputs its measurement digitally in a way the microcontroller can measure without a separate and expensive analog-to-digital chip. If we use tiny surface-mount components the circuitry will not take any more room than that needed to house the sensor itself.

With a probe this smart obviously there is a need for smarter probe software

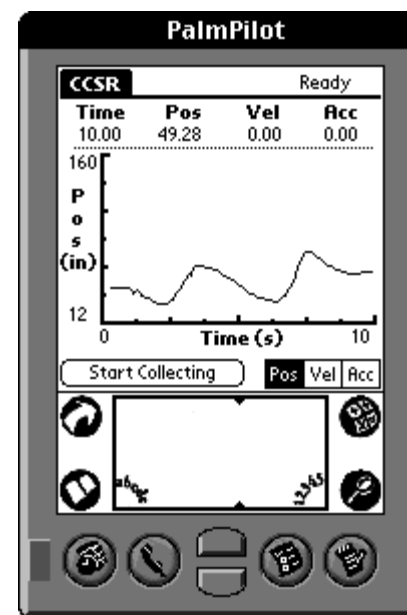

*The PalmPilot can display data collected by the Concord Consortium Sonic Ranger (CCSR).*

— software that would run on any computer platform and automatically start up whenever a SmartProbe is attached.

But that's another article. @

*Stephen Bannasch is the Concord Consortium's Director of Technology.  
stephen@concord.org*

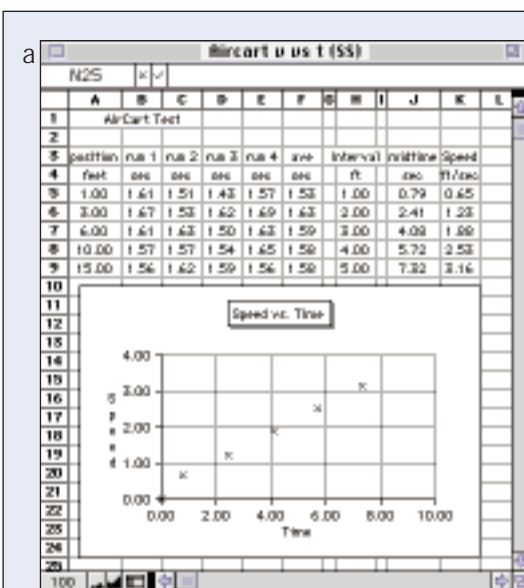

*Figure 7. Aircart speed vs. time.*

## Hands On Physics

*continued from page 7*

course for the aircart by marking distance intervals along the floor. Use uneven distance intervals - short in the beginning and longer near the end. We tried a 15 ft. course, starting with a 1 ft. interval and ending with a 5 ft. interval. That approach gave reasonable timing accuracy.

If you have MBL capability, you can get velocity information about the aircart using a "smart pulley." We had the aircart move about half a meter along a table top.

The aircart and other HOP units are written in HTML format and are available at our web site. HOP units are appropriate as the basis for a complete course in physics or may be used individually in conjunction with more traditional approaches. @

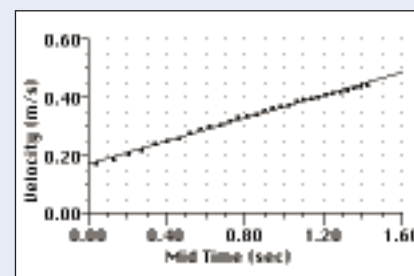

*Figure 8. MBL aircart speed vs time.*

LINKS ON THIS PAGE

[Hands On Physics](http://www.concord.org/HOP)—www.concord.org/HOP

[Analog Devices](http://www.analog.com)—www.analog.com

[PalmPilot](http://palmpilot.3com.com)—palmpilot.3com.com

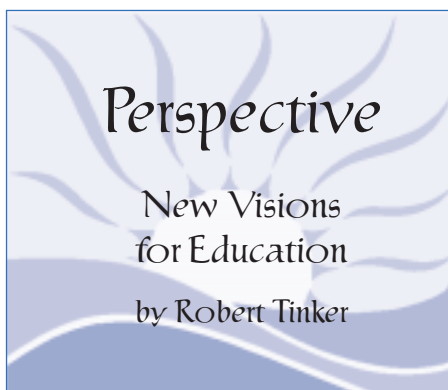

**“ Few people realize that a technology like the PalmPilot can be appropriated by education. ”**

Over the next year a profusion of low-cost computers will appear on the market with the potential to finally realize the educational promise of technology—if we can undertake a vigorous research program to support the curriculum advances they make possible.

Educational applications of computers and networking have been stalled because the technology is not widely available. In order to become sufficiently facile with sophisticated tool applications, learners need near-continuous access to these technologies. Only when one makes routine use of a range of tools can a learner reap their advantages, but when it happens, technology can dramatically accelerate learning.

Today “technology” in schools is almost synonymous with a desktop “personal” computer wired through a LAN to the Internet. This is the ideal configuration which, because of its purchase price and maintenance costs, very few students can use for any significant time. As new options become available over the next year this definition of technology will have to be expanded. Inexpensive set-top computers, handhelds, tablet computers, and wireless connectivity will change the landscape. The result is not simply cheaper desktop computers; the technology will be mobile, connected, and easy to use and maintain. The computers may have limited capacity, but every kid can have regular access to one or more and, through them, to the Internet.

We are not ready for these new opportunities. Few people realize that a technology like the PalmPilot™, which is targeted to a specialized segment of the business market, can be appropriated by education. But the PalmPilot is as powerful as the old Mac II and costs \$100-\$300. And it can run interesting educational software such as probeware (see “Making Smarter Probes,” page 5). As technologies like this become widely available over the next few years, the disparity between what could be taught and what is actually taught, increasingly will be obvi-

ous and intolerable. As educators, we need to expand our vision of where students can go and how computers can take them there. We need to harness all the resources available to exploit these new options. Tool applications must be shoe-horned into smaller computers. And new applications that take advantage of mobility and connectivity need to be developed.

Educational applications alone will not fulfill the educational promise of this technology. The full impact cannot be realized within the K-12 curriculum as currently implemented. Many important technology-based innovations are implemented only if they can fit into the definition of what is important as enshrined in the current curriculum. A curriculum is more than the topics taught; it is the interdependence of topics that allows them to build on each other. Current materials rarely build on the new learning options created by technological innovations. For instance, the well documented capacity of probeware to allow kids in elementary school to interpret graphs is not used to improve the teaching of algebra.

The full realization of the promise of information technologies in learning will require a new K-12 curriculum that incorporates interdependent technology-based learning goals. If students can understand graphs and decimals in fourth grade, then the entire math and science curriculum after fourth grade should build on that understanding.

The problem is that creating a new curriculum sequence is a massive effort that requires a better research base and extensive experience. One cannot experiment casually with what students should learn for fear of missing critical concepts or undermining student motivation. Yet, we must undertake this work, or see the educational potential of technology remain unrealized. @

*Robert Tinker is President of the Concord Consortium.*

**info@concord.org**



**Join Us Online**

### **International Alliance**

When math and science teachers in the U.S. talk about major challenges they face in the classroom, you often hear: How can we teach problem-solving skills? How can we better motivate the students to learn? How can we help students take responsibility for their own learning? How can we go beyond teaching for the test?

In March, by invitation of Educom, a division of Horizons Technologies Group of Companies, the Concord Consortium visited with a group of dedicated classroom teachers who asked the same questions. The difference was that these teachers are called the "best" in the world and their students score the highest in math and science on the international TIMS and Cambridge tests.

Those secondary teachers are in Singapore, where recent national headlines read "School workload to be cut by 10-30%" and "Less chalk-and-talk, more project work for students." The Concord Consortium learned that in Singapore the classroom focus is shifting away from one where the teacher is in total control to one where students are encouraged to think critically and ask questions. We hope to share in future professional and probeware development with Educom in Singapore and elsewhere. If you would like more information about our work in these areas, contact us at the email address below.



**ccservices@concord.org**

### **Lotus Specialty Program**

The Concord Consortium is a proud member of the Lotus LearningSpace™ Specialty Program, where we are recognized as having the skills and expertise necessary to help organizations develop, deploy and maintain LearningSpace-based distributed learning environments. Our experienced staff consults with businesses and academic organizations who need help implementing LearningSpace. We also assist in the conversion of traditional training platforms into online LearningSpace environments.

Three elements of our successful online professional development program for NetCourses are available on a fee basis. Courses are delivered through LearningSpace 2.5, which was released in March—

**Teacher Learning Conference** is a 26-week NetCourse that prepares teachers to create and teach a course in LearningSpace.

**Site Coordinator Learning Conference** is a 2-week orientation to LearningSpace for administrators and others who might provide technical support to students taking a LearningSpace course.

**LearningSpace Student Orientation** is a 2-week NetCourse designed to familiarize students with LearningSpace in order to improve their efficiency before they begin a course.

Contact us at CC Services for information and pricing.



**ccservices@concord.org**

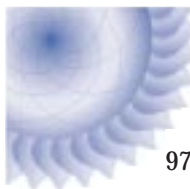

The Concord Consortium  
Educational Technology Lab  
37 Thoreau Street  
Concord, MA 01742  
978-369-4367 • FAX 978-371-0696

Nonprofit  
U.S. Postage  
PAID  
Boston, MA  
Permit No. 97